

1060304

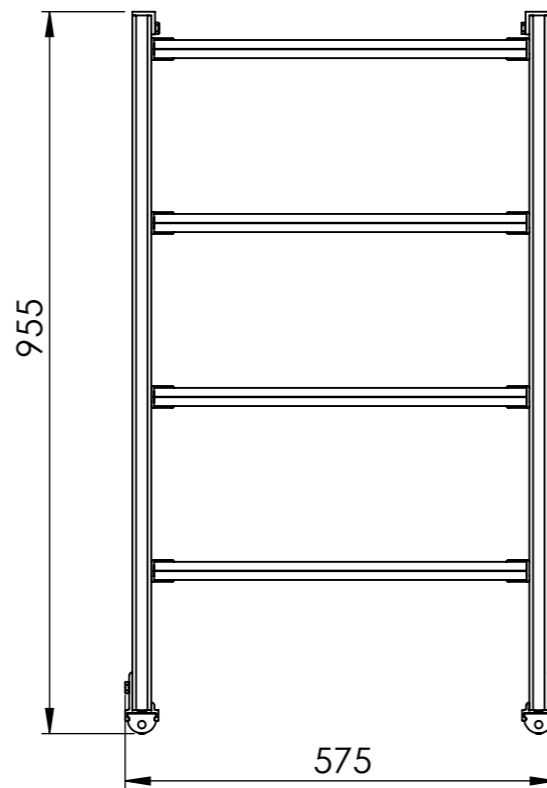
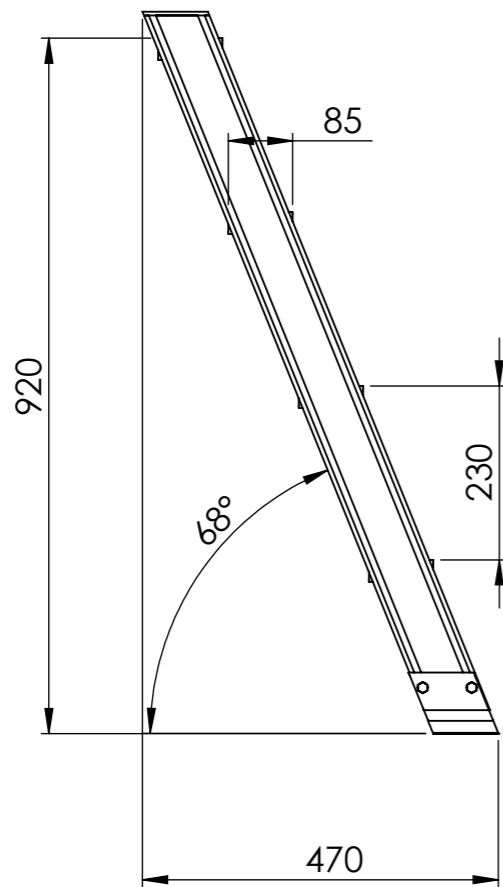
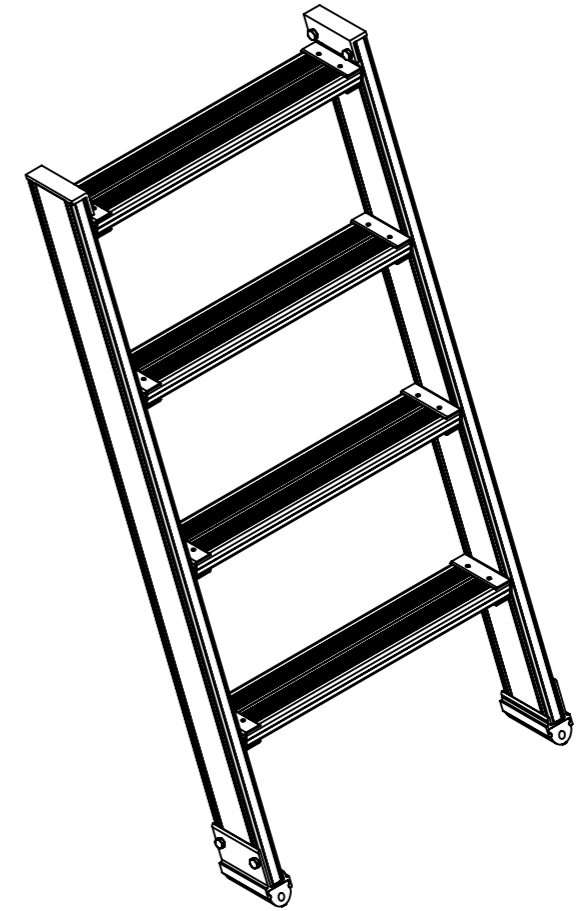
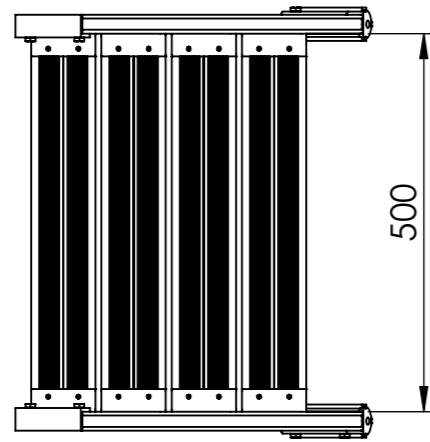

5 kg

ESLA